

# uDirect3 guide



**unitron.** Hearing matters

## Thank you

---

Thank you for choosing the Unitron uDirect™ 3. At Unitron, we care deeply about people with hearing loss. We work closely with hearing healthcare professionals to make advanced, purpose-driven solutions available to everyone. Because hearing matters.

The intended use of uDirect 3 is to wirelessly stream audio from different Bluetooth® devices to your hearing aids. For example, mobile phones, MP3 players etc.

You can also stream other audio devices directly via a plug. For example, computers, Roger and FM receivers.

uDirect 3 can also be used as a remote control to adapt your hearing aids to different listening situations.

 Please note that your hearing healthcare professional must configure your uDirect 3 before it can be used as a remote control for your hearing aids.

## Your uDirect 3

---

Hearing healthcare professional: \_\_\_\_\_

\_\_\_\_\_

Telephone: \_\_\_\_\_

Serial number of uDirect 3: \_\_\_\_\_

Warranty: \_\_\_\_\_

Date of purchase: \_\_\_\_\_

The uControl™ app can be downloaded at the App Store and Google play. Search for Unitron and select uControl.



## Quick reference

### Charging uDirect 3

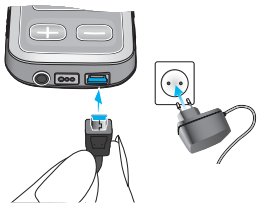

### Wearing uDirect 3

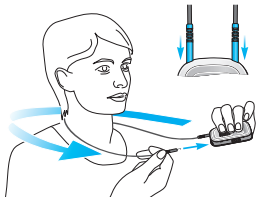

### Bluetooth pairing

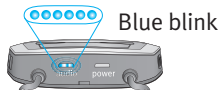
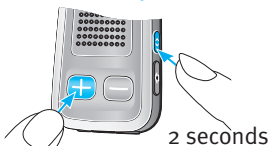

### On/Off

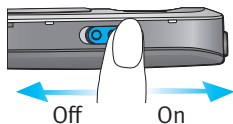

### Power indicator

Solid red - charging  
Solid green - fully charged  
Red blink - low battery  
No light - battery drained

### Audio indicator

Solid orange - audio jack or FM streaming  
Solid violet - demo sound  
Solid blue - Bluetooth streaming  
Blue short blink - 1 device connected  
Blue double blink - 2 devices connected  
Blue very fast blink - pairing

## Table of contents

Your uDirect 3 at a glance .....	2
Setting up the power supply .....	4
Charging the uDirect 3.....	5
Turning the uDirect 3 on and off.....	6
Summary of indicator lights .....	7
Wearing the uDirect 3 correctly.....	10
Operating distance.....	11
Button lock function.....	11
Testing sound via the uDirect 3 .....	12
Access button functionality .....	14
Spoken notifications .....	15
uControl app.....	16
Using uDirect 3 as a remote control for your hearing aid .....	17
Using uDirect 3 with a mobile phone .....	20
Advanced phone options .....	31
Using the external microphone .....	35
Using uDirect with uTV 3 .....	36
Using uDirect 3 with uMic.....	40
Using uDirect 3 with an audio device with Bluetooth.....	42
Using uDirect 3 with an audio device with a headphone jack..	45
Setting up the FM receiver.....	46
Managing multiple audio inputs to the uDirect 3.....	49
Resetting your uDirect 3 .....	52
Deleting the pairing of Bluetooth devices .....	53
Troubleshooting guide .....	54
Warnings .....	64
Information and explanation of symbols.....	71
Compliance information.....	73

# Your uDirect 3 at a glance

## Buttons

- 1 Access (A)
- 2 Volume (+/-)
- 3 Home (🏠)
- 4 Connect (↔)
- 5 On/Off switch (I/O)

## Inputs

- 6 Microphone openings
- 7 Audio input (3.5 mm jack)
- 8 FM input (Europlug)
- 9 Charging input (mini-USB)

## Indicators

- 10 Audio indicator
- 11 Power indicator (power)

## Neckloop

- 12 Neckloop sockets
- 13 Neckloop (with antenna)
- 14 Neckloop plugs

\*Can be configured by your hearing healthcare professional.

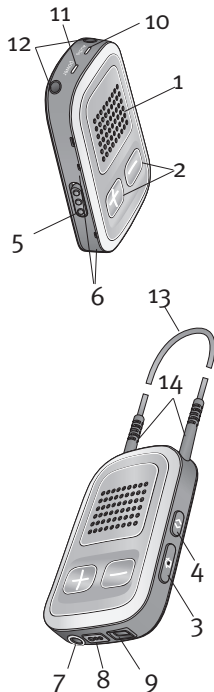

## Accessories

- 15, 16 Universal power supply with mini-USB plug
- 17-20 US, EU, UK, AUS adapter

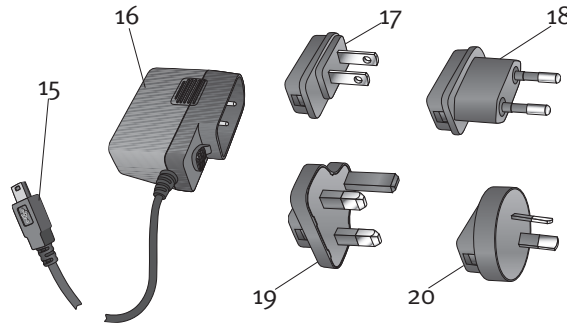

## Other optional accessories

- External lapel microphone 'MC1'
- Short neckloop (51 cm)
- Unitron uTV 3 (Bluetooth transmitter for TV use)
- Audio cable, 1.5 m / 5 ft.
- USB cable, 3 m / 10 ft.
- (Included country adaptors may vary by country.)

## Setting up the power supply

1. Select the adapter that corresponds to your country.

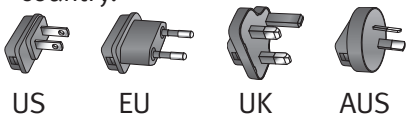

2. Insert the round corner of the adapter to the round corner of the universal power supply until it is completely inserted.
3. Click the tail of the adapter in to lock it into place. Make sure the adapter is securely locked.

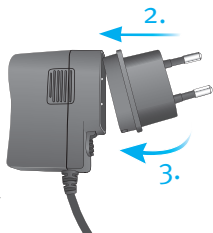

### To remove the power adapter:

1. Pull back the tab on the universal power supply and hold.
2. Gently pull the adapter upwards to remove it from receptacle.
3. Then start over with step one (above).

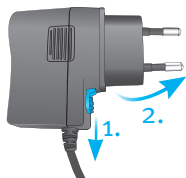

## Charging the uDirect 3

Your uDirect 3 has a non-removable rechargeable battery.

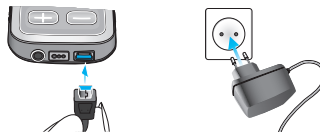

### To charge it:

1. Plug the mini-USB plug into the mini-USB port on the uDirect 3.



2. Plug the power supply into a power outlet. During charging, the power indicator is solid red, this typically takes 90 minutes. When the battery is fully charged, the power indicator is solid green.

It is safe to leave the uDirect 3 connected to the charger overnight.

-  When charging your uDirect 3 for the first time, let it charge for at least three hours, even if the battery indicator is not lit or turns green earlier.
-  uTV™ 3 can also be used as a charging station for uDirect 3.

## Turning the uDirect 3 on and off

Slide the power switch (I/O) as shown to turn the uDirect 3 on or off.

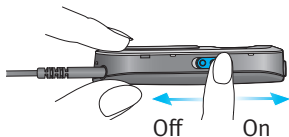







Switch the uDirect 3 off when not in use or if in storage or during transportation.

For operational use switch the uDirect 3 on.

## Summary of indicator lights

The indicator lights provide helpful information as follows:

### Power indicator

Charging	Solid red	
Charged and full battery	Solid green	
Switching on	Green 2 seconds	
Switching off	Blink red, then solid 2 seconds*	
Battery above 10%, normal operation	Slow blink green **	
<10% battery, charging required (at least 2 hours)	Short blink red**	
Battery dead, charging required (at least 2 hours)	No light after switching on	
Enable/disable lock state	Short blink red (lock) or short blink green (unlocked)	

\* When switching the uDirect 3 off, the power indicator may blink red first while the uDirect 3 is properly disconnecting all Bluetooth devices.

\*\* If the neckloop is not connected to the uDirect 3, the battery level is only shown during startup, charging and when a button is pressed.

 After unplugging the neckloop the uDirect 3 enters power down mode after two minutes and the power indicator goes off. Only the remote control functions can be used while the neckloop is unplugged.

## Battery state







The color of the power indicator informs you about the uDirect 3 battery state.

The green power indicator indicates a battery level > 10%.

The red power indicator indicates a battery level < 10%. Less than one and a half hours streaming remain and the battery should be charged for at least two hours.

## Audio indicator

The neckloop must be plugged in for any streaming.

Plug or FM streaming	Solid orange	
Bluetooth phone or music streaming	Solid blue	
One Bluetooth device connected	Short blink blue	
Two Bluetooth devices connected	Double-blink blue	
Bluetooth pairing	Very fast blue blinking	
Demo sound playing	Solid violet	

 The Bluetooth pairing indication will be visible even if the neckloop is not plugged in.

 During cable or FM streaming, the audio indicator will remain orange regardless of the Bluetooth connection state.

## Wearing the uDirect 3 correctly

Before any phone, music or TV streaming can take place, the uDirect 3 must be switched on and worn correctly as shown below:

1. Put the neckloop around your neck (easily done by unplugging one neckloop plug).
2. Make sure both plugs are well connected in the neckloop sockets.
3. Switch the uDirect 3 on.

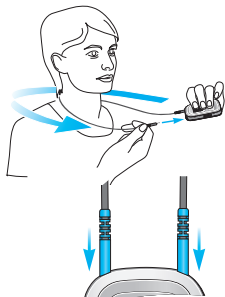

 For streaming, the neckloop must always be plugged in. When unplugged, the uDirect 3 will go into sleep mode after two minutes. The power and audio indicators will stop blinking and all active Bluetooth connections are terminated to save power. Plug the neckloop in again to activate the streaming.

## Operating distance

If uDirect 3 is used as a handheld remote control (without neckloop):

- Maximum distance 110 cm/43”
- Hold uDirect 3 as shown





## Button lock function

The access (A) button on your uDirect 3 can be locked to avoid inadvertent presses. To lock the button, press and hold the connect (↔) and Home (🏠) buttons simultaneously. The power indicator light will flash red three times to indicate that the buttons have been locked.

Press and hold the connect (↔) and Home (🏠) buttons simultaneously again to unlock the buttons.

You will still be able to answer an incoming telephone call using the access (A) button while it is locked.





-  The power indicator is lit as long as you press a uDirect 3 button. Green confirms a good uDirect 3 battery state, red indicates that you need to charge the uDirect 3 battery.
-  Two minutes after unplugging the neckloop both indicator lights will switch off and the uDirect 3 disconnects Bluetooth to save power.

## Testing sound via the uDirect 3

---

1. Wear the uDirect 3 correctly.
2. Press and hold the access () button while switching on the device. Release the access button. The audio indicator light will turn violet.

The hearing aids will switch to the streaming mode and you will hear the uDirect 3 sound demo.

Use the volume () () buttons to adjust the volume.

The sound demo will stop after three minutes or when the access button is pressed. Adjusting the volume during the sound demo

will also set the volume level of the spoken uDirect 3 messages.

If you cannot hear the sound demo:

- Make sure your hearing aids are inserted correctly.
- Make sure the uDirect 3 neckloop is properly plugged in on both ends and worn around your neck.
- Make sure the uDirect 3 is charged and switched on.
- Make sure you are not on a phone call connected through the uDirect 3.

## Access button functionality

---

The access button has multiple functions:

- **Phone:** Manages telephone functions such as accepting and ending phone calls. See the section “Using uDirect 3 with a smartphone or cell phone” for more information.
- **Streaming:** It pauses and resumes the streaming from an audio device.
- **Remote control:** It can be used to select the hearing aid programs.



## Spoken notifications

---

Spoken notifications inform you about the different operation modes and status of the uDirect 3 using text-to-speech, for example low battery.

Your hearing healthcare professional can configure the language setting as well as which notifications are spoken.

- ❗ **Caller identification is independent of the spoken notifications level.**
- ❗ **Spoken notifications must be enabled by your hearing healthcare professional.**

## uControl app

---

The uControl is a smartphone app which offers quick and easy volume and program adjustments.

It also provides:

- individual left and right volume control
- additional program controls
- easy Bluetooth pairing



## Using uDirect 3 as a remote control for your hearing aid

---

 Before the remote control functionality can be used, your hearing healthcare professional must enable the remote control.

There are two ways to use the uDirect 3 as a remote control:

- The neckloop is plugged in with both ends, and the uDirect 3 must be worn around your neck. The remote control function is available as long as you are not streaming audio.
- The neckloop is completely un-plugged and uDirect 3 is operated at arm's length. No streaming is possible in this configuration.

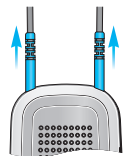
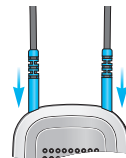

Make sure the uDirect 3 is switched on.

## Volume change

Press the (+/−) volume button on the uDirect 3 to adjust the volume of your hearing aids:

- Press (+) to increase loudness
- Press (−) to decrease loudness

## Program change

Use the access (A) button to change hearing aid listening programs.

Changing hearing aid programs is only possible if no streaming is in progress.

Press and hold the home (🏠) button (⌘ two seconds) to select your favorite hearing program configured by your hearing healthcare professional.

Push the home (🏠) button to return to the startup hearing aid program and volume levels of your hearing aids.

## More remote control information

- Your hearing aids may beep to confirm that your selection was applied.
- Both hearing aids are controlled at the same time.
- The available hearing aid programs and volume levels are set by your hearing healthcare professional.

## Using uDirect 3 with a mobile phone

If you have a mobile phone equipped with Bluetooth functionality (e.g. iPhone or android), uDirect 3 may be used to stream phone conversations wirelessly to your hearing aids allowing you to hear the callers voice directly in your hearing aids. uDirect 3 picks up your voice through its own microphone and streams it to your mobile phone.

During phone calls, the access (A) button provides a range of features that help you manage your calls.



To benefit from the pairing of the uDirect 3 and your mobile phone, we recommend wearing the uDirect 3 around the neck. During calls, your voice can only be picked up if the uDirect 3 is not covered by clothes.

If you wear the uDirect 3 under clothing during phone calls, the external Unitron microphone “MC1” is needed (see the section in this guide on using the external microphone).

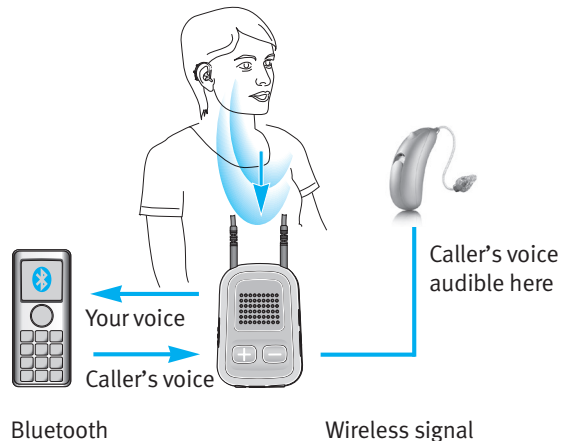









### Pairing your mobile phone

1. Enable Bluetooth on your mobile phone settings menu.
2. Ensure that the uDirect 3 is turned on and the neckloop is plugged in and worn correctly. Press the connect (↔) and the volume up (+) buttons at the same time for two seconds. The audio indicator will blink blue to indicate pairing mode on the uDirect 3.

3. Enable Bluetooth pairing mode on your mobile phone so that a new device can be added. See manufacturer instructions for details. If prompted, enter “0000” for pairing code.
4. If prompted, accept request to grant uDirect 3 access to your phone book. It is used for voice calling and caller ID features.
5. Confirmation of successful connection is indicated on the uDirect 3 when the audio indicator stops blinking blue. Additionally a headset symbol () may appear on the main screen of your mobile phone.

Once pairing is done, your mobile phone should pair automatically with the uDirect 3.

-  Please contact your hearing healthcare professional if you can not complete the pairing procedure with the steps described.
-  The pairing process does not require the neckloop to be plugged in. For streaming and Bluetooth connection, the neckloop is mandatory.

-  To receive phone calls your phone must support either the Bluetooth “Head Set” (HSP) or “Hands Free” (HFP) profile. When pairing to your phone, it may ask you which Bluetooth service you want to enable. Select “Headset” or, if available, “Stereo Headset.”
-  To access caller ID features, your phone must support the Phone Book Access Profile (PBAP)
-  When pairing to a cellular phone, we recommend disabling the phone key tones and SMS alerts.
-  To listen to stereo music from your phone, it must support the A2DP/“Stereo Headset” profile.
-  A maximum of eight devices can be paired to the uDirect 3. A ninth pairing will overwrite the pairing of the device that has not been used in the longest amount of time.
-  The uDirect 3 can support (connect) two phones at the same time but only one call at a time is possible.

## Preparing for phone calls

The Bluetooth range (maximum distance between uDirect 3 and the phone) is 5-10 m (15-30 ft).

Outside this range, the connection will be lost or you will encounter intermittency during a call.

When engaged in any phone call, wear the uDirect 3 normally as shown below (figure a).

- In very noisy environments, you may move the uDirect 3 closer to your mouth (figure b).
- Avoid covering the small microphone openings on the side with your fingers or clothes (figure c) and do not speak from the front (figure d).

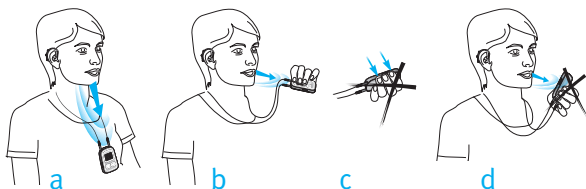

Some phones are configured to play key-press tones, SMS announcements and confirmation beeps to the uDirect 3.

If this is set you will hear these tones interrupting any active audio streaming through your hearing aids. Your hearing aids may briefly switch to streaming mode which may be unwanted.

Please refer to your phone user guide for information about disabling these sounds.

- ❗ Phone calls via Bluetooth will always take priority over other audio sources on your uDirect 3.
- ❗ It is not possible to change hearing aid programs using uDirect 3 during a phone call.
- ❗ You will hear the caller's voice through both hearing aids.

## Making phone calls

Use the phone keypad to enter the number and press the phone dialing button.

When connected, you will hear the dialing tone through your hearing aids after approximately three seconds.

### Using cordless phones (DECT) or older phones with headset profile only

If your phone only supports the headset profile (HSP), the connection must be initiated manually for outgoing calls. This often applies to cordless home phones (DECT standard).

 For these phones, the audio indicator might not blink blue even if the phone is paired.

1. Dial the number you want to dial on your phone, or select it from the phone book.
2. Briefly press the connect () button, then wait five seconds.
3. The dialing process will automatically start and the audio indicator will turn solid blue. You may hear a confirmation beep through your hearing aids.

## Incoming calls

The uDirect 3 must be switched on, paired to the phone and worn correctly.

When a call is received on your phone, the uDirect 3 audio indicator will show a solid blue light, and you will hear the ringtone signal through your hearing aids.

### Accepting incoming calls

To accept an incoming call, briefly press the access () button on your uDirect 3 once you hear the ringtone through your hearing aids. It will take about five seconds before you hear the ringtone through your hearing aids.



Speak into the uDirect 3, not into the phone, when the call is in progress.

 For your safety, the hearing aid microphones will remain on at reduced levels during phone calls and audio streaming.



-  Only one phone call at a time is possible. A second ringing phone is ignored while another call is already connected. You must disconnect the first call before answering the second one.

## Ending a call

To end a phone call via your uDirect 3, briefly press the access (A) button. The call will terminate and your hearing aids will return to the previously-active program or audio source (such as the audio jack input).

You can also end a call by operating your phone instead of your uDirect 3.

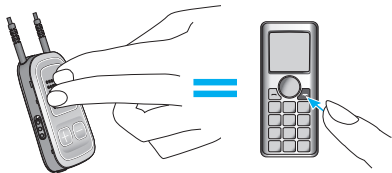



## Different ringtones of the uDirect 3

The phone ringtone depends on the uDirect 3 configuration and your phone capabilities.

The ringtone is assigned automatically during the initial phone pairing process and cannot be configured.

When pairing more than one phone, the second and third paired phone will have a different ringtone. A total of three different ringtones are automatically assigned.

The uDirect 3 will also announce the caller name as shown on the phone display (caller identification using text-to-speech technology). The name is taken from your phone's directory.

-  Please note that this feature must be supported by your phone. Please consult the phone user guide or the phone supplier for more information.
-  The default language setting of a new uDirect 3 is US English. Your hearing healthcare professional may configure the appropriate language setting for proper pronunciation of the names. Your hearing healthcare professional may switch the caller identification off upon your request.

## Rejecting a call

If you prefer not to answer an incoming call, press and hold the access (A) button on your uDirect 3 for two seconds until the ringtone stops. Using your phone to reject the call will have the same effect.

Pressing the home (H) button will reject the call and the hearing aids will switch to the startup program.

## Advanced phone options

---

Your hearing healthcare professional may configure the following additional features on uDirect 3. They will be assigned to a long press (two seconds) of the access (A) or the connect (C) button:

 Your mobile phone must support these features. Please consult the phone user manual for details.

### Redial last number

A long press of the access (A) button will redial the last dialed number.

### Voice dial

A long press of the connect (C) button will start the voice dial which allows you to speak the person's name instead of typing the number.

 When using two phones at the same time, only the last paired phone can be used for voice dial.



## Hold call

While in a phone conversation, a long press of the connect () button will put the call on hold. The caller stays on the line but there is no audio transfer and the hearing aids switch to the previous hearing program. Use this mode to have a side conversation with a person next to you without transmitting the conversation to the person on the phone.

## Transfer call

While in a phone conversation, a long press of the access () button will transfer the call to the phone. This allows you to hand your phone to another person. Your hearing aids will switch back to the previous hearing program.

After holding or transferring a call, another long press of the access () button transfers the call back to the uDirect 3 and the call is resumed through your hearing aids.

 As long as the call is on hold or transferred, you may use the access () button to change your hearing aid programs again.

## Caller identification, spoken caller names

The uDirect 3 may be able to tell you the name of the caller.

If your phone supports Phone Book Access (PBA) or Phone Book Access Profile (PBAP), the uDirect 3 will try to access information about the caller every time the phone rings.

As the phone rings, the displayed information is transferred to the uDirect 3 and spoken through your hearing aids as follows:



- The stored name in your phone's phonebook. In the example, you will hear “Mike Office”
- The phone number, if the name is not known



To make sure the pronunciation is correct your hearing healthcare professional can configure the language settings of your uDirect 3.

The phonebook is not downloaded to the uDirect 3. This way, uDirect 3 can also support the use of different phones.

Please consult your phone's user guide or the phone dealer to check whether this feature is supported by your phone.

-  Some hearing aid models do not support caller identification.
-  Caller identification must be enabled by your hearing healthcare professional.

## Using the external microphone

Use the optional external lapel microphone “MC1” if you wear the uDirect 3 underneath clothing during a phone call.

1. Plug the 3.5mm microphone plug into the audio input of the uDirect 3, disabling the internal uDirect 3 microphones.
2. Use the clip to place the omnidirectional microphone as close to your mouth as possible.
3. Put the neckloop around your neck and switch the uDirect 3 on.

Jackets, etc., will not negatively influence the wireless link to your hearing aids.

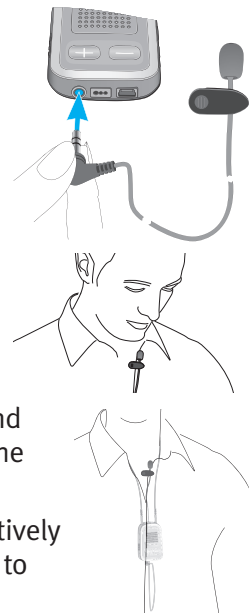

## Using uDirect with uTV 3

If you have a uTV™ 3, you can:

- Stream audio from your TV up to 30 m (90 ft) to your hearing aids
- Recharge your uDirect 3 in the charging cradle

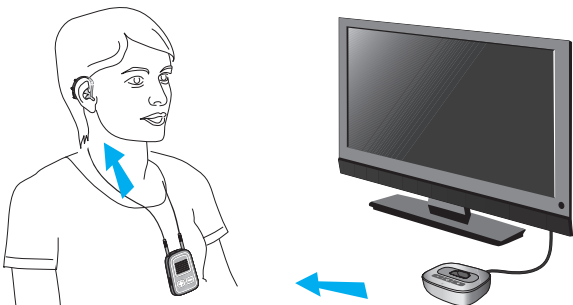

### Charging your uDirect 3 on the charging cradle

1. Ensure the uTV 3 has the correct charging cradle for the uDirect 3 – see uTV 3 manual for details.
2. Ensure the uTV 3 is turned on and place the uDirect 3 into the charging cradle.

3. Allow two hours for a full charge.

### Pairing uTV 3 to uDirect 3

1. Switch on the uDirect 3 first. Press the connect (↔) and volume up (+) buttons at the same time for two seconds.
2. Switch on the uTV 3 and then press the pair button on the back of the uTV 3. The main indicator light on the uTV 3 will start rapidly blinking blue. Make sure uTV 3 and the uDirect 3 are within 1 m (3 ft) range.
3. After successful pairing, the blue audio indicator on the uDirect 3 and uTV 3 will stop blinking.

### Playing back audio from your TV



1. Begin playback on your TV.
2. Adjust the volume level on the uTV 3 to a medium to high level.
3. Make minor volume adjustments with the uDirect 3 volume buttons (+/-).

## Pausing playback

If you want to temporarily stop streaming to hear a conversation, press the (A) button to pause the streaming. Press the (A) button again to resume streaming.

## Stopping playback

To stop playback on your device and switch back to regular hearing programs, press and hold the access (A) button for two seconds.

-  Changing hearing aid programs is not possible while streaming.
-  Please contact your hearing healthcare professional if you can not complete the pairing procedure with the steps described.
-  uDirect 3 is capable of streaming up to 20 hours with a fully charged battery.

## Adjusting the volume

Press the uDirect 3 volume (+) (-) buttons to adjust:

- Press (+) to increase the volume
- Press (-) to decrease the volume

-  Adjusting the volume on the uDirect 3 will have the same effect as adjusting the volume of the hearing aids and may also amplify surrounding sounds.

## Changing the program

Changing hearing aid programs is only possible if no streaming is in progress.

Press the access (A) button to change hearing aid programs.

Press the home (🏠) button to return to the startup program and volume level of your hearing aids.

## Using uDirect 3 with uMic

If you have a uMic, it works with uDirect 3 to stream audio from a person or device to your hearing aids.

hearing aid wearer

speaker

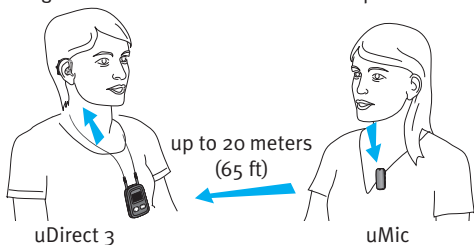

### Pairing uMic to uDirect 3

1. Starting with the uMic in the off position, press and hold the volume up (+) button and turn the uMic on. Continue to hold the volume up (+) button until the blue audio indicator starts to flash.
2. Switch on uDirect 3 first. Press the connect (<>) and volume up (+) buttons at the same time for two seconds.
3. After successful pairing, the blue audio

indicator on the uDirect 3 and uMic will stop blinking.

### Playing back audio from your uMic



1. Clip the uMic to a person, or position it near a sound source such as a speaker or TV.
2. Adjust the volume level on the uMic to a medium to high level.
3. Make minor volume adjustments with the uDirect 3 volume buttons (+/-).

### Pausing playback

If you want to temporarily stop streaming, press the (A) button to pause the streaming. Press the (A) button again to resume streaming.

### Stopping playback

To stop playback on your device and switch back to regular hearing programs, press and hold the access (A) button for two seconds.

-  Changing hearing aid programs is not possible while streaming.
-  Please contact your hearing healthcare professional if you can not complete the pairing procedure with the steps described.



 uDirect 3 is capable of streaming up to 20 hours with a fully charged battery.

## Using uDirect 3 with an audio device with Bluetooth

---



If you have an audio source equipped with Bluetooth functionality (e.g., MP3 player), you can stream audio wirelessly to your hearing aids.

### Pairing your Bluetooth audio device:



1. uDirect 3 must be switched on and worn correctly.
2. Press the connect () and volume up () buttons at the same time for two seconds until the audio indicator starts to rapidly blink blue.
3. Start the pairing process on the Bluetooth device within one minute according to the device's user guide and use code "0000" if prompted.

4. Switch on the other Bluetooth device.
5. For some Bluetooth devices it may be necessary to press "play" on the device.
6. If the devices were paired and connected correctly, streaming will start automatically and the audio indicator will turn solid blue.

### Playing back audio from your device

1. Begin playback on your device.
2. Adjust the volume level on the device to a medium to high level.
3. Make minor volume adjustments with the uDirect 3 volume buttons ( ) .



### Pausing playback

If you want to temporarily stop streaming to hear a conversation, press the () button to pause the streaming. Press the () button again to resume streaming.



## Stopping playback

To stop Bluetooth streaming completely, switch the other Bluetooth device off or disable its Bluetooth feature.

-  **Note:** Please refer to the device's user guide or dealer support if you cannot complete the pairing procedure with the generic steps described.
-  **Note:** uDirect 3 streaming time is more than 20 hours with a fully charged battery.
-  **Note:** Changing hearing programs is not possible while streaming.

## Using uDirect 3 with an audio device with a headphone jack

---

To benefit from the streamer and remote control functions, we recommend wearing the uDirect 3 around the neck.

### Streaming music via a cable

The uDirect 3 must be switched on and worn correctly around your neck.

1. Insert the audio cable into the headphones socket on your audio player and start the player.
2. Insert the other end of the audio cable into the audio input on your uDirect 3. The audio streaming is automatically activated.

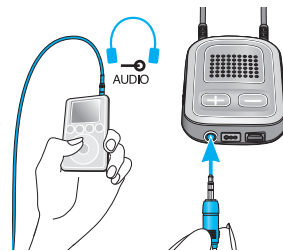

Briefly press the access (A) button to stop and restart streaming.

## Setting up the FM receiver

uDirect 3 can be used together with FM equipment.

1. Place the FM transmitter near the sound source and turn it on.
2. Turn the FM receiver on if required.
3. uDirect 3 must be switched on and worn correctly.
4. Attach your FM receiver to the uDirect 3 via the FM input as shown in the picture.

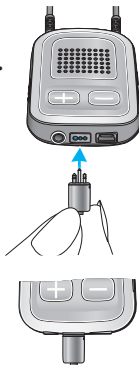

When FM is detected, you will hear the FM notification tone for streaming through your hearing aids. The FM notification tone is similar to a phone ringtone.



Options for handling the FM signal during the FM notification tone:

- **Accept:** Briefly press the access (A) button.
- **Put on hold:** Press the access (A) button for two seconds.

- **Ignore the FM notification tone:** After 20 seconds the FM will be put on hold automatically.

Briefly press the access (A) button to pause the FM signal during streaming.

The FM input that is paused is automatically kept in the background and can be restarted as long as an FM signal is present by briefly pressing the access (A) button.

-  **As long as an FM signal is streaming the hearing aid programs cannot be changed via the access (A) button.**
-  **Note: After 20 seconds the input will be put on hold automatically if you do not accept it.**
-  **If uDirect 3 does not receive a signal through the Europlug for three minutes, an alert will be heard. This alert will be repeated every 15 minutes until you stop the Europlug streaming.**

The uDirect 3 will play a confirmation sound each time the streaming via FM is activated and the audio indicator will turn orange.

The uDirect 3 will send a short alert signal during FM streaming if there is no FM signal for 45 seconds, and then every 15 minutes thereafter.

If there is no FM signal for more than 15 minutes, the notification tone restarts as soon as the FM signal is detected again.

To deactivate FM completely, unplug the FM receiver from the uDirect 3.

## Managing multiple audio inputs to the uDirect 3

When an audio source is connected via the uDirect 3, your hearing aids will automatically switch to special programs.

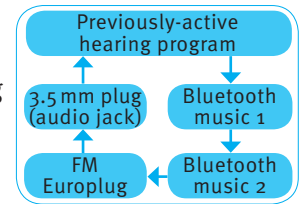

It is possible to have multiple audio sources connected and in operation with the uDirect 3:

- Two Bluetooth devices (e.g., phone and uTV 3)
- One audio input (3.5 mm audio plug)
- One direct audio input (Europlug)

Spoken status indicators and the audio indicator light inform you about the connected inputs.

An audio source is considered as “connected” to the uDirect 3 if:

- The audio plug is inserted (with or without audio signal)

- An FM receiver is inserted and receiving an FM signal
- A Bluetooth music source is streaming music or paused
- A Bluetooth phone is paired and within reach

 A phone call always has priority. You will hear the ringing indication even when listening to other audio sources via cable, Bluetooth or FM. If you reject or terminate the call, audio streaming will resume.

 It is not possible to change hearing aid programs using the access (A) button as long as any audio source is connected to the uDirect 3.

 If you want to listen to music from your connected mobile phone, you must start the music via your phone initially; it cannot be started from the uDirect 3.

## Selecting from multiple inputs using the uDirect 3

With only one audio source (e.g., from a Bluetooth transmitter), each press of the access (A) button will pause or resume the audio source.

Multiple sound sources can be accessed sequentially by pressing the access (A) button. After each press, the uDirect 3 selects the next connected source in a fixed sequence.

If a source is not connected, the uDirect 3 will skip over it and proceed to the next source.

Every connected audio source has a fixed place in the sequence, as shown in the diagram.

 Pressing the home (H) button will always select the startup programs of your hearing aids, regardless of the audio source sequence.

## Resetting your uDirect 3

---

If, for some reason, the uDirect 3 becomes unresponsive:

1. Slide the uDirect 3 power switch to the on position.
2. Press and hold the (↔), (🏠) and (−) button simultaneously for two seconds.
3. Slide the uDirect 3 power switch to the off position.
4. Wait for five seconds.

The uDirect 3 is now reset and will resume normal operation when switching on again.

 After resetting the Bluetooth pairings, the configuration status and the grouping to the hearing aids are kept.

## Deleting the pairing of Bluetooth devices

---

If you encounter issues with one of the paired devices, or if a device stops connecting to your uDirect 3, you may consider deleting the pairing of devices to the uDirect 3.

1. Turn on your uDirect 3.
  2. Press and hold the (↔) and (+) buttons for ten seconds until the blue rapid blinking audio indicator stops.
  3. Also delete the uDirect 3 pairing entries on your mobile phone before any re-pairing.
  4. Repeat the pairing procedure.
-  Deleting the pairing of Bluetooth devices removes the ability to connect to these devices. You will need to perform the pairing process again if you wish to reconnect.



## Troubleshooting guide

Cause	Possible remedy
<b>During Bluetooth pairing my other device is prompting for a code, what do I have to enter?</b>	
The pairing code is required for the initial coupling of uDirect 3 with your Bluetooth device (pairing)	The uDirect 3 pairing code is “0000” (four zeros)
<b>I hear intermittency during audio streaming via uDirect 3</b>	
The Bluetooth device is too far away, or worn in a back pocket (body shielding)	Do not to exceed the maximum distance 5-10 m (15-30 ft) and keep Bluetooth devices in front of you
uDirect 3 searches for known devices for two minutes after switching on	After two minutes, uDirect 3 will stop searching and the intermittency will stop
A phone connected to other devices, such as a PC, may not be able to continuously stream music	When using your Bluetooth phone as music player, disconnect it from other devices, such as PCs

Cause	Possible remedy
<b>The volume of the music is too loud or too quiet. The volume of phone conversations is not comfortable (too low or too high)</b>	
Different audio sources have different outputs	Reduce the hearing aid volume by pressing the  button. If the sound volume over the phone (or music) is too low after this reduction use the phone volume button to increase the volume. To change the volume of the phone or any other sound source streaming to uDirect 3, first adjust the overall level of the device and make minor adjustments on your uDirect 3
<b>I have difficulties understanding the phone conversation in a noisy environment</b>	
Your hearing aid microphones are set too high during the call	Reduce the environmental noise by pressing the volume down button for two seconds and then use the phone volume button to increase the phone volume

Cause	Possible remedy
-------	-----------------

### The caller can hear me but I cannot hear the caller

The call was transferred to your phone	Make sure the call is transferred back to uDirect 3 via the phone menu or long press of (A) button
--	--

### uDirect 3 is no longer recognized by the phone or other Bluetooth device to which it was previously paired

Two minutes after no device was found, uDirect 3 stops seeking devices to save power	Switch uDirect 3 off, wait until the red indicator switched off, then turn device on again
--	--

The devices are too far away from each other	Bring devices within one meter of each other and try again
--	--

uDirect 3 can be paired to a maximum of eight different Bluetooth devices. If the internal memory is full, new pairings may overwrite previous pairings	Repeat the pairing between uDirect 3 and the Bluetooth device which was overwritten
---	---

Pairing was deleted	Repeat the pairing between uDirect 3 and the Bluetooth device which was deleted
---------------------	---

Cause	Possible remedy
-------	-----------------

### I am not streaming but the hearing aids keeps switching between the Bluetooth and the normal hearing aid program

Your phone sends sounds to uDirect 3 due to incoming SMS or mails	Disable the system sounds for reminders, alarms, SMS, etc. via your phone menu
---	--

Phone key tones are switched on	Switch off phone key tones via your phone menu
---------------------------------	--

### I hear my phone's key-press tones in my hearing aids

The key-press tones may be enabled on your phone	Deactivate key-press and confirmation tones on your phone. Please refer to the phone's user guide
--	---

### Every time I switch on my phone, the music player starts

For some phones this is normal behavior and not initiated by uDirect 3	Some phones can be configured not to start the music player automatically. Press and hold the access button to stop streaming. Stop the music player via phone menu after the phone is connected
--	--

Cause	Possible remedy
-------	-----------------

When I get into my car, the uDirect 3 connection to my phone shows unexpected behavior

The car Bluetooth system connects to your phone	Consider disconnecting the car system from your phone
---	---

I accepted the incoming phone call but cannot hear the call in my hearing aids

Some phones don't use uDirect 3 when accepting the call through the phone button	Always accept the call by pressing the uDirect 3 access (A) button
--	--

Cause	Possible remedy
-------	-----------------

The phone is ringing but the audio indicator is NOT solid blue and there is no ringing signal through the hearing aids

Bluetooth is disabled in the phone	Ensure Bluetooth is enabled according to your phone's user guide
------------------------------------	--

uDirect 3 and your phone are not connected to each other	<ol style="list-style-type: none"> <li>1. Disable the Bluetooth functionality in your phone and turn it on again</li> <li>2. Restart uDirect 3 by switching it off and then on. The uDirect 3 Bluetooth functionality will be automatically reactivated</li> <li>3. Activate uDirect 3 by selecting it in the phone's "Active device" menu</li> <li>4. Reduce the distance between uDirect 3 and the phone</li> </ol>
--	---

uDirect 3 is not paired to the phone	Follow the pairing process in this guide
--------------------------------------	--

The distance is too great between uDirect 3 and the phone	Wear uDirect 3 around your neck. Keep distance to phone within <5m (15ft)
---	---



Cause	Possible remedy
<b>The phone is ringing, the audio indicator is solid blue but there is no ringing signal through the hearing aids</b>	
uDirect 3 is out of range of the hearing aids	Wear uDirect 3 correctly around your neck with both neckloop plugs firmly plugged in
Phone is set to vibrate	Enable ring tone on phone
If you are already on a phone call, then a second call cannot be recognized	Hang up the first phone call, then accept the second call

**My phone rings but the name of the caller is not being spoken by uDirect 3**

The caller identification feature is not available or not enabled on your phone	Please refer to the phone's user guide to check the availability of this feature
Two phones are connected to your uDirect 3	If two phones are connected, caller identification is only available on the phone that was last paired to uDirect 3
Caller identification may be switched off	Please ask your hearing healthcare professional to enable caller identification on your uDirect 3

Cause	Possible remedy
<b>During a phone call the other party reports difficulties hearing me</b>	
uDirect 3 microphone openings may be covered	Make sure the microphone openings are not covered by part of your body, clothing or dirt and debris
uDirect 3 may not be worn correctly	Do not turn uDirect 3 sideways and make sure the neckloop plugs point towards your mouth as you speak
uDirect 3 may rub against clothing	Reduce movement while you speak, or consider using the external microphone (optional)
The surrounding noise may be too loud	Although uDirect 3 features noise reduction technologies, very noisy environments should be avoided. Suggest to your callers that they increase the phone volume, or hold the uDirect 3 closer to your mouth

Cause	Possible remedy
-------	-----------------

**uDirect 3 is unresponsive or does not show any indicator when switching ON**

uDirect 3 may be completely discharged	Charge your uDirect 3 for at least 1 hour
It may indicate a software problem	Unplug any connectors from uDirect 3. Switch uDirect 3 off and on again. Consider resetting uDirect 3

**The operating time of your uDirect 3 is reduced substantially**

The battery typically needs several charging cycles to achieve full performance	Charge for at least 3 hours the first time you charge uDirect 3. Let a new uDirect 3 discharge completely three times
---	--

**I have interruptions while my audio streaming is active**

uDirect 3 is too far away from the hearing aids while streaming	Wear uDirect 3 clipped to your clothing with a maximum 40 cm (16") distance to the hearing aids
Bluetooth signal is out of range	Keep the Bluetooth device within the operating range

Cause	Possible remedy
-------	-----------------

**I cannot hear the demo sound**

Hearing aids are not worn correctly	Make sure your hearing aids are inserted correctly
uDirect 3 is not worn correctly or switched off	Wear uDirect 3 clipped to your clothing with a maximum 40 cm (16") distance to the hearing aids. Make sure uDirect 3 is charged and switched on

For any problems not listed in this user guide, please contact your hearing healthcare professional.

## Warnings

---

- 👤 Please read the information on the following pages before using your Unitron uDirect 3.

### Hazard warnings

- ⚠️ Keep this device out of reach of pets and children under three years.
- ⚠️ Only use hearing aids that have been specially programmed for you by your hearing healthcare professional.
- ⚠️ Changes or modifications to any of the devices that were not explicitly approved by Unitron are not permitted.
- ⚠️ Do not wear uDirect 3 around the neck while it is connected to any programming equipment.
- ⚠️ Make sure to always remove both plugs of the neckloop and other cables when using the uDirect 3 as a handheld remote control.

- ⚠️ Opening the uDirect 3 might damage it. If problems occur which cannot be resolved by following the remedy guidelines in the troubleshooting section of this user guide, consult your hearing healthcare professional.
- ⚠️ This product has an embedded, non-replaceable battery. Do not attempt to open the product or remove the battery as this may cause injury and damage the product.
- ⚠️ Dispose of electrical components in accordance with your local regulations.
- ⚠️ Do not use the device in explosive areas (mines or industrial areas with danger of explosions, oxygen rich environments or areas where flammable anesthetics are handled) or where electronic equipment is prohibited.
- ⚠️ External devices may only be connected if they have been tested in accordance with corresponding IECXXXXX standards. Only use accessories approved by Unitron.

- ⚠ Using your uDirect 3 cables in any way contradictory to their intended purpose (e.g., wearing the USB cable around the neck) can cause injury.
- ⚠ When operating machinery, ensure that no parts get caught in the machine.
- ⚠ The mini-USB port is to be used for the described purpose only.
- ⚠ Caution: electric shock. Do not insert plug alone into electrical outlets.

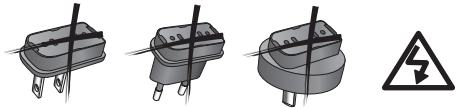

- ⚠ For safety reasons, only use chargers supplied by Unitron or stabilized chargers with a rating of 5VDC, min. 500 mA.

## Information on product safety

- ⚠ Check your hearing aid compatibility with your hearing healthcare professional.
- ⚠ Protect the uDirect 3 from excessive moisture (bathing, swimming), heat (radiator, car dashboard), and direct skin contact when sweating (workout, fitness, sports).
- ⚠ Special medical or dental examination including radiation described below, may adversely affect the correct functioning of your remote. Remove and keep it outside the examination room/area before undergoing a medical or dental examination with X-ray (also CT scan) or any medical examinations with MRI/NMRI scans, generating magnetic fields.
- ⚠ Do not drop the device. Dropping onto a hard surface can damage your device.
- ⚠ Protect the uDirect 3 from excessive shock and vibration.

- ⚠ Do not use excessive force when connecting your uDirect 3 to the different cables.
- ⚠ Protect all openings (microphones, antenna, audio, FM and charger) from dirt and debris.
- ⚠ Never use a microwave or other heating devices to dry the uDirect 3.
- ⚠ Clean the uDirect 3 using a damp cloth. Never use household cleaning products (washing powder, soap, etc.) or alcohol to clean the uDirect 3.
- ⚠ The digitally-coded, inductive transmission technology used in the uDirect 3 is highly reliable and experiences virtually no interference from other devices. It should be noted, however, that when operating the hearing system near computer equipment, larger electronic installation or other strong electromagnetic fields, it may be necessary to be at least 60 cm (24") away from the interfering device to ensure proper operation. Keep the device at least 10 cm away from any kind of magnets.

- ⚠ Do not disconnect the neckloop while the uDirect 3 is transmitting signals to your hearing aids.
- ⚠ For safety reasons, recharge the uDirect 3 only with chargers supplied by Unitron or with USB-certified chargers >500 mA.
- ⚠ Do not connect an USB or audio cable exceeding 3 meters (9ft) in length to the uDirect 3.
- ⚠ When the uDirect 3 is not in use, turn it off and store it safely.

### Other important information

- ⚠ High-powered electronic equipment, larger electronic installations and metallic structures may impair and significantly reduce the operating range.
- ⚠ If the hearing aids do not respond to the uDirect 3 because of an unusual field disturbance, move away from the disturbing field.

- ⚠ Your hearing aids and uDirect 3 are given a unique communication code during the fitting. This ensures that the device will not affect hearing aids worn by others.
- ⚠ When using an FM transmitter, be aware that radio signals might also be picked up and overheard by other receivers.

## Information and explanation of symbols



With the CE symbol, Unitron confirms that this Unitron product – including accessories – meets the requirements of the Medical Devices Directive 93/42/EEC as well as the Radio Equipment Directive 2014/53/EU on radio and telecommunications transmitters.



This symbol indicates that it is important for the user to read and take into account the relevant information in this user guide.



This symbol indicates that it is important for the user to pay attention to the relevant warning notices in this user guide.



Important information for handling and product safety.



Australia and New Zealand EMC and Radiocommunications compliance label.



This symbol shall be accompanied by the name and the address of the authorised representative in the European Community.



This symbol shall be accompanied by the name and the address of the manufacturer (who are placing this device on the market).

---

## Operating conditions:

This device is designed such that it functions without problems or restrictions if used as intended, unless otherwise noted in these user guides.

0° to 45° Celsius and relative humidity of <95% (non condensing).

---

## Transport and storage conditions:

During transport or storage, the temperature should not exceed the limit values of -20°/60° Celsius and relative humidity of 90% for a long period of time. The air pressure between 500 and 1100 hPa is appropriate.

---



The symbol with the crossed-out garbage bin is to make you aware that this device may not be thrown away as normal household waste. Please dispose of old or unused devices, at waste disposal sites intended for electronic waste, or give your device to your hearing healthcare professional for disposal. Proper disposal protects the environment and health.

---

 **Bluetooth** The Bluetooth® word mark and logos are registered trademarks owned by Bluetooth SIG, Inc. and any use of such marks by Unitron is under license. Other trademarks and trade names are those of their respective owners.

---



Apple and the Apple logo are trademarks of Apple Inc., registered in the U.S. and other countries. App Store is a service mark of Apple Inc.

---



Google Play is a trademark of Google Inc.

---

---

## Compliance information

### Declaration of Conformity

Hereby, Unitron Hearing declares that this product meets the requirements of the Medical Device Directive 93/42/EEC and complies with Radio Equipment Directive 2014/53/EU. The full text of the Declarations of Conformity can be obtained from the manufacturer.

### Notice 1:

This device complies with Part 15 of the FCC Rules and with RSS-210 of Industry Canada. Operation is subject to the following two conditions:

- 1) this device may not cause harmful interference, and
- 2) this device must accept any interference received, including interference that may cause undesired operation.

### Notice 2:

Changes or modifications made to this device not expressly approved by Unitron may void the FCC authorization to operate this device.

### Notice 3:

This device has been tested and found to comply with the limits for a Class B digital device, pursuant to Part 15 of the FCC Rules and ICES-003 of Industry Canada. These limits are designed to provide reasonable protection against harmful interference in a residential installation. This device generates, uses and can radiate radio frequency energy and, if not installed and used in accordance with the instructions, may cause harmful interference to radio communications. However, there is no guarantee that interference will not occur in a particular installation. If this device does cause harmful interference to radio or television reception, which can be determined by turning the equipment off and on, the user is encouraged to try to correct the interference by one or more of the following measures:

Reorient or relocate the receiving antenna.

Increase the separation between the device and receiver.  
Connect the device into an outlet on a circuit different from that to which the receiver is connected.

Consult the dealer or an experienced radio/TV technician for help.



Australia: Supplier Code Number N15398

New Zealand: Supplier Code Number Z1285



Unitron Hearing, a division of  
National Hearing Services Inc.  
20 Beasley Drive, P.O. Box 9017,  
Kitchener, ON N2G 4X1 Canada



Sonova AG  
Laubisrütistrasse 28 CH-8712  
Stäfa, Switzerland

For a listing of Unitron group  
companies, please visit  
[www.unitron.com](http://www.unitron.com)







Distributor

[unitron.com](http://unitron.com)

